

1100-0531 with brackets instruction sheet

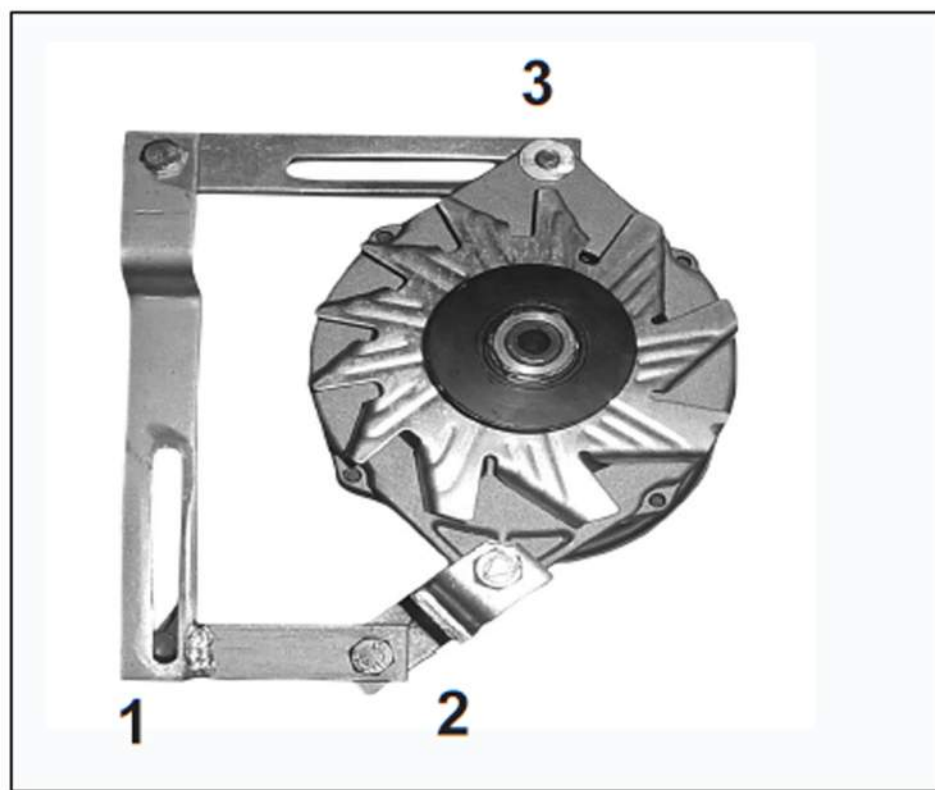

1 Corner attaches to water pump.

2 Bolt attaches to where the generator was previously.

3 Is your adjustment for the belt tension.

Installation Instructions for Atlantic Conversion Kit

1100-0531 – ALTERNATOR COVERSION KIT
FITS FORD 8N SERIAL NO. 263844
EQUIVALENT TO TISCO # 8NL10300ALT

CAUTION: NEGATIVE GROUND BATTERY ONLY







*Parts not supplied with kit

1. REMOVE EXISTING GENERATOR, MOUNTING BRACKET(S), WIRING HARNESS, AND VOLTAGE REGULATOR
2. INSTALL NEW 12V ALTERNATOR WITH BRACKETS SUPPLIED (SEE DIAGRAM)
3. INSTALL COIL RESISTOR SUPPLIED, REFERENCE WIRING DIAGRAM TO INSTALL WIRING HARNESS (ALL BULBS MUST BE CHANGED TO 12V)
4. INSTALL 12V, NEGATIVE GROUND, BATTERY. CHECK BATTERY TERMINAL ON ALTERNATOR, IT SHOULD BE HOT AT ALL TIMES.
5. START TRACTOR. AS ENGINE SPEED INCREASES, ALTERNATOR WILL BEGIN TO CHARGE.

NOTE:

After long periods of no use or disassembly, it may be necessary to re-excite the alternator. With the engine running use a jumper wire between the battery and "R" terminal.

WIRE CODE

	Red
	Red & White
	White
	Orange
	Yellow
	Blue

